

MIT POLIERTEM MAGNETBOHRER, GRIFF AUS
ZWEIKOMPONENTENMATERIAL MIT DREHBAREM ENDETEIL FÜR
PERFEKTEN HALT.

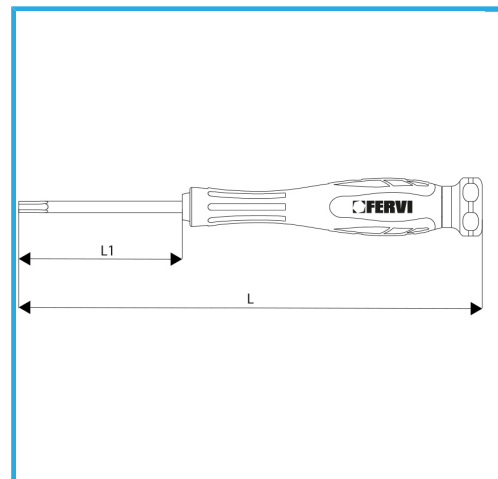

Maß	2,5 mm
Stangenlänge	50 mm
Gesamtlänge	140 mm
Bruttogewicht	0,02 kg
Verpackungsmaße	19x19x145h
EAN-Code	8012667349189



Phosph.



-



Cr-V

-